

YASKAWA

U1000

INDUSTRIAL MATRIX DRIVE

IT'S PERSONAL



U1000 INDUSTRIAL MATRIX DRIVE

A CLASS OF ITS OWN

The U1000 is a highly efficient AC drive based on Yaskawa matrix technology. With full power regeneration capability, the U1000 offers great energy saving potential while sinusoidal input currents and a near unity power factor reduce stress on grid components like transformers and power lines. With a compact footprint, the U1000 is the first choice for innovative, energy-efficient drive solutions with or without power regeneration.

**PROVEN
POWERFUL
RELIABLE**

INNOVATIVE MATRIX TECHNOLOGY



The U1000 can be used for standard and regenerative applications with the unique advantage of direct AC-to-AC power conversion. This unique design offers the best choice for induction motors (IM) and permanent magnet motors (PM). Benefits include low input current harmonics with near unity power factor allowing for increased energy efficiency. The bi-directional switching technology allows for continuous motoring or continuous regeneration. This means that fewer parts are required, leading to higher machine reliability. Moreover, the U1000 can automatically switch into across-the-line operation through the drive, eliminating drive generated harmonics, drive losses, and motor noise.

ENERGY SAVING 4Q OPERATION



Thanks to matrix technology, the U1000 can operate in full, continuous regeneration. It is your best drive for applications like conveyor, winder, escalator, lift or test bench, where braking energy needs to be considered. The AC to AC design does not require any braking resistor which takes space in the cabinet and creates additional heat during regeneration. Best of all, no parameter settings are needed to enable the U1000's regeneration. The U1000 can instantaneously and automatically switch from full motoring operation to full regenerative operation.

FUNCTIONAL SAFETY BUILT-IN



U1000 has integrated SIL3 and PLe Safe Torque Off (STO) performance. It is also TUV tested and certified to ISO/EN13849-1 Cat.3 PLe and IEC/EN61508 SIL3 (two safety inputs and one EDM output).

COST SAVING



In addition to a reduction of energy consumption, the U1000 provides cost-saving benefits through a simplified installation and smaller panel requirements. The U1000 eliminates braking resistors that convert regenerative energy into heat which can be a safety concern in some application environments.

CLEAN POWER



The sinusoidal input current, with a total harmonic distortion of less than 5%, and a displacement power factor of approximately 1.0, minimize losses in grid components like generators and transformers. This, at the same time, greatly reduces the potential of disturbance of other devices and improves the reliability of your system.

TIME SAVING INSTALLATION



As no external components like harmonic filters or active front end units are required, connecting a U1000 drive becomes a matter of minutes. 3 wires in, 3 wires out. It cannot be easier to build a low harmonic regenerative solution.

LOW HARMONIC SOLUTION



The U1000 offers the best low harmonic solution in one unit. It does not need any external devices to facilitate IEEE 519 compliance. Its harmonic performance meets the most stringent requirement of IEEE 519 at the input of the drive, making it an all around green solution. Its input harmonics remain low, not just at rated power, but well below leading harmonic solutions throughout the speed/load range.

COMPACT SIZE



The U1000 is an all-in-one compact solution for low harmonics and regeneration. There is no smaller solution. Save as much as 80% space. Retrofit and upgrades are made easy, since it easily fits in nearly every existing 18-Pulse package.



MATRIX DRIVE TECHNOLOGY

The evolution of variable speed drive technology stems from the need to boost motor control performance and to provide clean, efficient use of line power. To that end, recent advancements in drive technology have made way for a drive to use Matrix technology.

MATRIX DRIVE ARCHITECTURE

A drive using Matrix technology is different than conventional drives. The difference lies within the Matrix technology itself. Unlike conventional drives, Matrix Drives employ a system of nine bi-directional switches arranged in a Matrix to convert a three-phase AC input voltage directly into a three-phase AC output voltage. Matrix technology eliminates the need for a rectifying circuit and DC smoothing circuit found in conventional AC drive inverters. A Matrix drive incorporates a compact input PWM filter to mitigate the regenerative PWM waveform and provide a clean sine wave back onto the line.

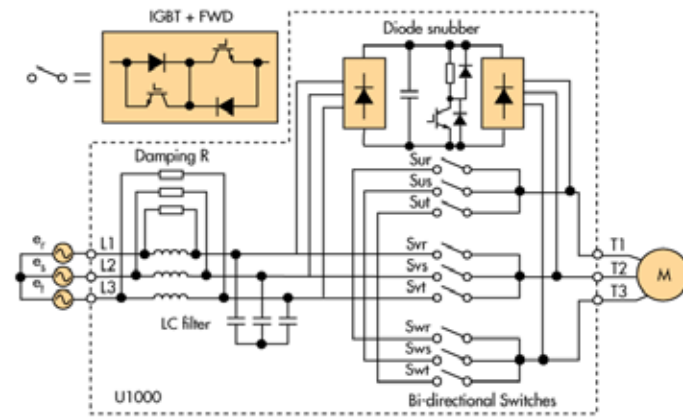

OUTPUT WAVEFORM

The beauty of the way the matrix drive generates its output waveform is the resulting input current draw. Unlike other low input harmonic current solutions the matrix drive does not force current into the drive to reduce harmonics. The matrix drive draws current with low harmonics naturally. Each time the drive generates a pulse to the motor using the input voltage a corresponding current draw occurs. Current is drawn from the line during each and every step of the variable three level output. Generating a full PWM output voltage waveform to control the motor naturally results in an input current waveform that is sinusoidal with low harmonic currents. The matrix drive can operate at rated power with less than 5% iTHD at the input of the drive with near unit power factor (0.98 or better).

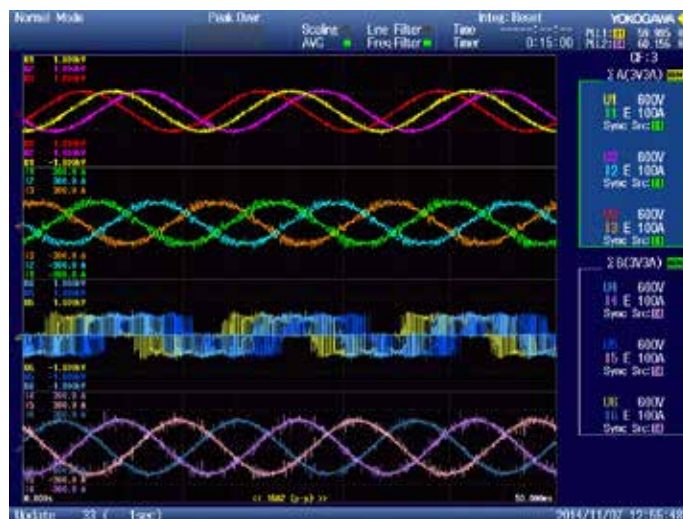

WINNER OF INTERNATIONAL AWARDS

The milestone product for harmonic suppression, regenerative energy savings and space savings.



**COMPACT
CREATIVE
INNOVATIVE**

THE ENGINEER'S CHOICE

The U1000 is the fastest to commission low harmonic and regenerative drive in the market. The U1000 eliminates components and reduces wiring while boosting power factor, harmonic performance, and system efficiency. From retrofits to new installations, the all-in-one compact design simplifies the drive selection process.



**SMART
SIMPLE
EASY**

REGENERATED POWER

The best-suited solution for regenerative applications, the U1000 eliminates the need to install external braking units and braking resistors. It returns the braking energy directly back to the power supply.

BUILT-IN POWER REGENERATION

The U1000 is a very compact AC to AC drive, which means there is no DC bus inside. This innovative design does not need any braking resistors which wastes the regenerative energy in heat. Now, the regenerative energy can be used by other loads on the same power grid, saving total energy cost and consumption while also reducing the panel cooling system requirements.

- Energy savings
- Less heat generation, reduced need for ventilation
- No braking resistor - greatly reduced risk of fire
- Less maintenance
- Fewer parts
- Compact design

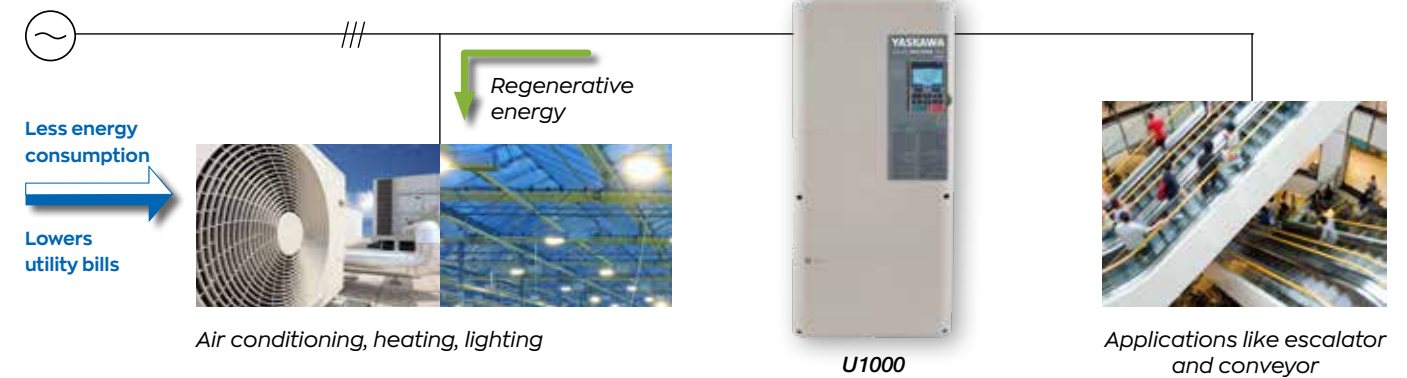

SYSTEM SIZE REDUCTION

Conventional dynamic braking solutions with braking transistors and braking resistors need lots of space and cooling. The U1000 matrix drive is a simple 3 wire in, 3 wire out configuration. This advantage in design reduces the footprint of your application, saving about 50% on wiring and weight while also saving 100% of wasted energy and eliminating the risk of fire by overheating the braking resistors.

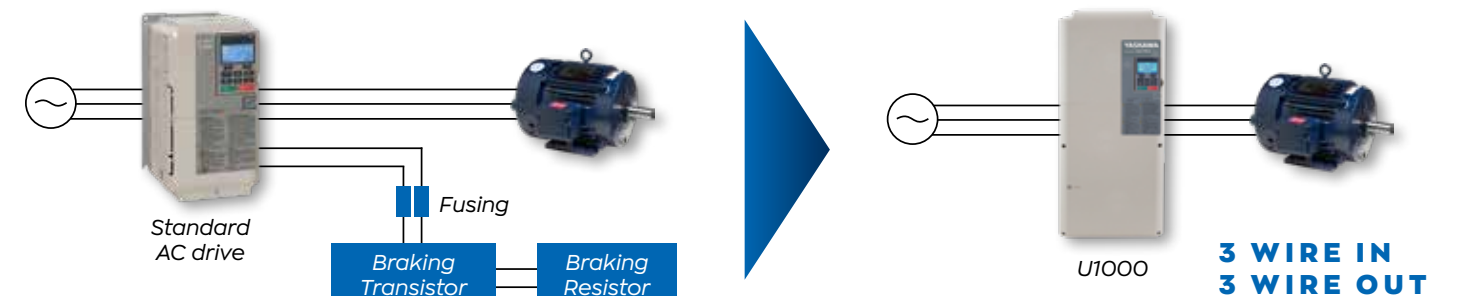

Eliminate components

- No additional braking transistors
- No additional braking resistors
- No additional fusing

- Reduce Wiring by **50%**
- Reduce Size by **70%**
- Reduce Weight by **50%**
- Reduce Wasted Energy by **100%**

ULTIMATE PERFORMANCE

The U1000 Industrial Matrix Drive is suitable for both heavy and light industry applications. Capable of operating induction and permanent magnet motors in both open loop and closed loop control.



U1000 is designed for rough applications. This extremely compact all-in-one solution offers optimum performance for standard and regenerative applications.

KEY APPLICATIONS

TEST STANDS



Test Stands require compact design, efficient and effective use of utility power, full regeneration, and multiple motor control methods. Engine test stands, tire load testers, transmission dynes, wind tunnel balancing equipment, etc. are examples of applications that take advantage of each and every benefit of the U1000.

WINDERS



Winding is a procedure designed to take up and package material in roll form, for more efficient handling or preparation for another operation. In a typical industrial use, winders are employed to roll up or unroll a continuous or limited length of material such as wire, paper, film, metal or textiles. The U1000 is ideal for unwinding applications providing constant tension. IEEE-519 compliant ultra-low harmonic Matrix technology provides full regenerative capability and continuous operation, eliminating down time due to braking resistor overheating or high DC bus overvoltage fault conditions.

PUMPJACKS



Pumpjacks are used above ground to drive liquid from deep submersible wells using a reciprocating piston pump. The weight of the horse head used to push/pull the rod creates an unbalanced load condition, even with a counterweight. As the rod falls, its speed passes the operating speed of the pumpjack and creates a regenerative condition that can be as high as 50% of the cycle of the pump. The U1000 seamlessly switches back and forth from operating in a motoring condition to a regenerative condition, thereby saving the energy instead of wasting it with bulky dynamic braking resistors. Ultra-low harmonics produce less transformer heating, which means a smaller transformer can be used to power the system.

WATER/WASTEWATER TREATMENT



Water/wastewater treatment consists of a wide variety of pump and fan applications. Pumping applications include mixers, sludge pumps, and chemical feed pumps, while fan applications include blowers and aerators. Installation space limitations and low input current harmonics requirements in public works facilities result in high-cost solutions. The U1000 Industrial Matrix Drive provides a compact all-in-one solution that can be smaller (60+%), lighter (80+%), less complex (70+% less wiring with fewer components), better performing (lower iTHD levels), and more efficient (+19%), compared to other low harmonic options.

INDUSTRIAL FANS/PUMPS



Industrial Fans/Pumps have long taken advantage of a VFD's ability to save energy by reducing speed. The U1000 offers the same advantage but with the additional benefits of IEEE-519 compliant ultra-low harmonics and near unity power factor. The addition of Eco-Mode allows the U1000 drive to pass line power directly to the motor to improve drive efficiency and eliminate any input current harmonics. Using Eco-Mode during periods of peak demand allows the drive's IGBTs to avoid switching on and off during the highest load demand, which results in longer life for the drive.

DOWNHILL CONVEYORS



Conveyors are used in a broad range of industries and applications to move packaged goods, assemblies, process byproducts, or any material from one place to another. A process designer will typically look for opportunities to use the force of gravity to accomplish product movement. Electric motors are commonly used when gravity cannot be employed or when the speed of a gravitational fall needs to be controlled. During these conditions the conveyor will be in continuous regeneration. The U1000 provides a compact all-in-one solution to continuously regenerate rated power conditions back onto the utility line. Remote installations can reduce transformer sizing by taking advantage of the U1000's low harmonic capabilities and near unity power factor.

CLEAN POWER

The Matrix Drive's unique direct AC-to-AC drive conversion process allows for a natural input current draw with IEEE 519 facilitating low input current harmonics. Enjoy low input harmonic performance at every speed/load operating condition.



**GREEN
EFFICIENT
ENERGY SAVING**

CLEAN CURRENTS

Facilitates IEEE 519 compliance at the input of the drive.

CLEAN POWER



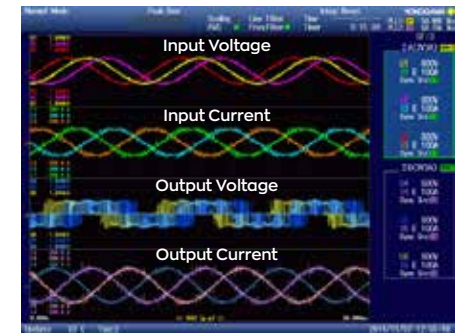
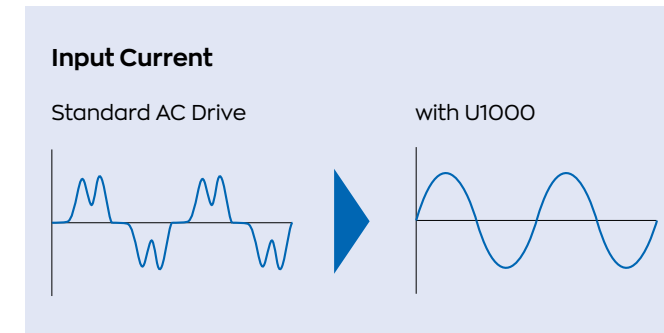

U1000 is the answer to power quality, energy savings, and system efficiency improvement. The advanced technology of the Yaskawa matrix drive combines all application key features in a single space-saving drive design reducing THDi to 5% without the need for external transformers or heavy filtering.

- No oversizing of transformers, generators or cables
- Sinusoidal input current and power factor at ~0.98
- Compact installation - 3 wire in, 3 wire in
- Reduced lifecycle cost
- Reliable operation
- Facilitates IEEE 519 Compliance

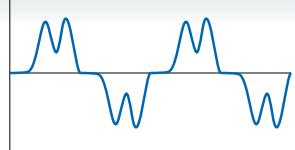

Matrix Drive Rated Power Operation

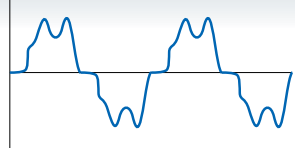
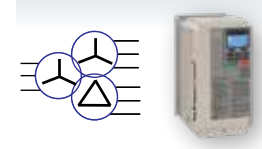
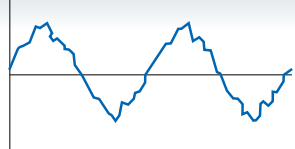
THE IDEAL ENERGY-SAVING CLEAN POWER FOR YOUR APPLICATION

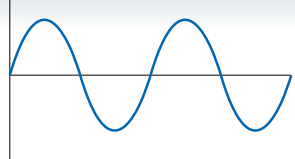
		(Data shown below taken at rated power)		
	Standard AC drive		88% Current distortion	0.75 Power factor
	Standard AC drive with DC reactor		33% Current distortion	0.9 Power factor
	12-pulse system with Standard AC drive		7 - 12% Current distortion	0.95 Power factor
	U1000 Industrial Matrix Drive		3 - 5% Current distortion	0.98 Power factor

EASY MODERNIZATION

SYSTEM EFFICIENCY

The AC-to-AC design of the matrix drive creates a sinusoidal input current. It means the U1000 provides a power factor close to 1. This near unity power factor makes it possible to reduce losses in generators, transformers, and cables. When installing the U1000 you can even design a smaller grid capacity for new installations or add more drives to existing power lines without additional stress to the power transformers.

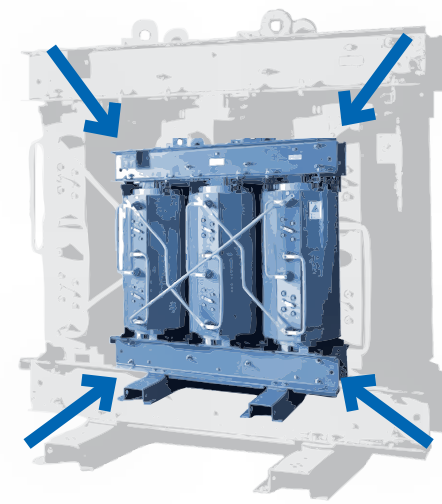

Significantly lower your system size when modernizing

MODERNIZATION

Yaskawa Matrix Technology has been successfully proven in the field of low harmonic, space saving and regenerative applications. Eliminate wasteful dynamic braking packages, reduce transformer burden or sizing requirements, retrofit aging equipment using existing panels, and reduce existing operational costs using the more efficient direct AC-to-AC Matrix drive design.

- Low harmonic (facilitate IEEE 519 Compliance)
- No need for braking transistors and braking resistors or additional fusing
- Significant reduction in panel cooling requirements
- Easy conversion from an existing to a new system
- 100% of resistor's wasted energy saved
- Designed for 10 years of maintenance-free use

BUILT-IN FUNCTIONAL SAFETY

U1000 comes with a built-in dual-channel safe torque off (STO) function that meets the requirements of SIL3 and PLe, offering an easy way to improve machine safety without the need for complex external wiring.

- TUV certified according to EN/ISO 13849-1 (PLe), IEC 62061 (SIL3)
- Simple wiring
- Less components
- Higher reliability
- Space saving

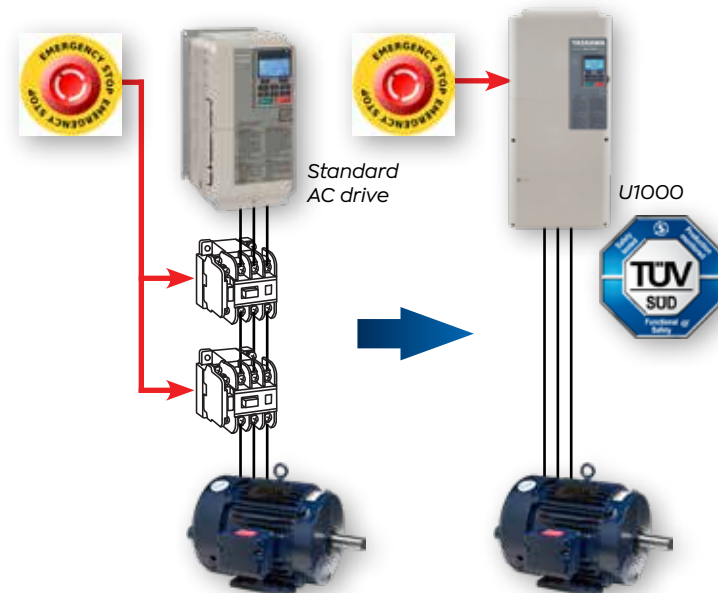

COMPACT EFFICIENCY

ECO-MODE - BUILT-IN ACROSS-THE-LINE (BYPASS) FUNCTION

The U1000 has a built-in bypass function. Whenever an application is matching the grid frequency, the U1000 can synchronize the motor to grid frequency. This built-in bypass function eliminates switching losses and any drive generated current harmonics and electrical motor noise.

- Eliminates drive noise (EMC/RF)
- Eliminates all drive generated harmonics
- Prolonged drive motor lifetime
- Drive fault detection monitoring still active
- Eliminates audible motor noise

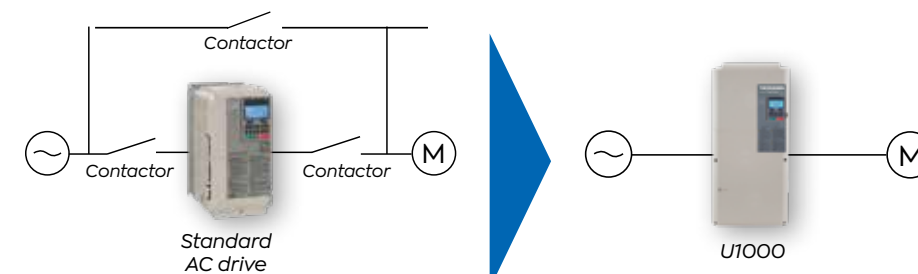

Conventional VFDs require external contactors to "bypass" the drive

Built-in automatic Bypass (Synchronous transfer from VFD to Grid and vice versa)

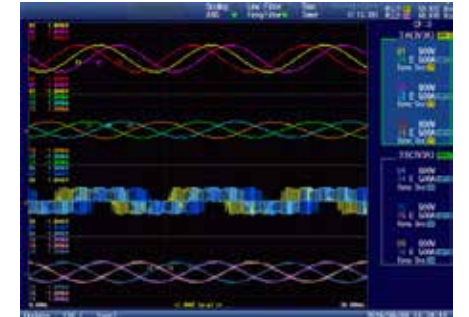

Matrix Operation: Rated Speed, Rated Torque

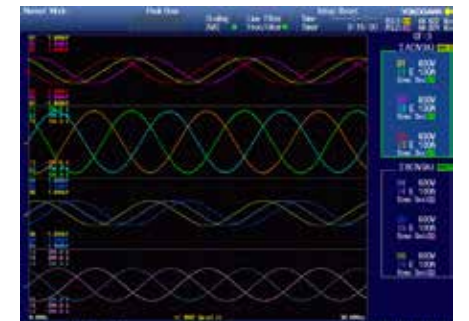

Eco-Mode Operation: Rated Speed, Rated Torque

COMPACT AND EASY

The U1000 design advantages, compared to conventional dynamic braking solutions, continues in saving installation space (up to 50%), reduced weight and 100% save of wasted energy. All you need to connect is 3 wires in and 3 wires out.

- Smaller panels
- Very compact footprint
- Simple installation in shortest time
- Perfectly fits in existing installations - easy retrofit

COMPLEX

12/18-PULSE SYSTEM

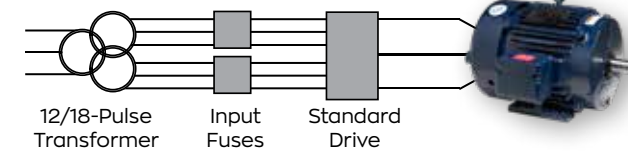

ACTIVE COMPONENT SYSTEM

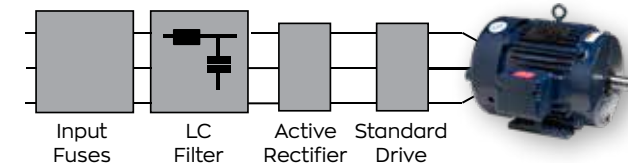

SIMPLE



3 WIRES IN, 3 WIRES OUT

- Fewer components
- Less Space
- Faster Setup
- Higher Efficiency

CONTROL MADE EASY

Unleash all that the U1000 has to offer with Yaskawa's intuitive and flexible PC-based interface tools. Enjoy DriveWizard® for configuring, advanced monitoring, trending, and file storage. Create custom functions with DriveWorksEZ®.

DRIVEWIZARD DESKTOP

- Complete online/offline parameter management PC support tool.
- Connect via USB and interface with the U1000.
- Create configurations offline, then later connect and download them to U1000.
- Monitor a dashboard of dynamic variables and discrete information.
- Chart your process with up to 6 channels of recorded data.
- Create reports for exporting and emailing.

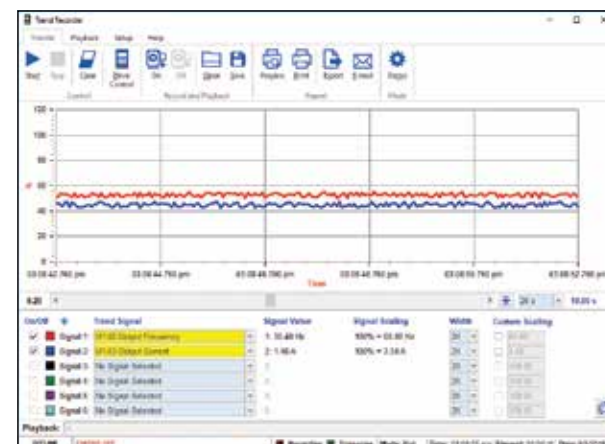
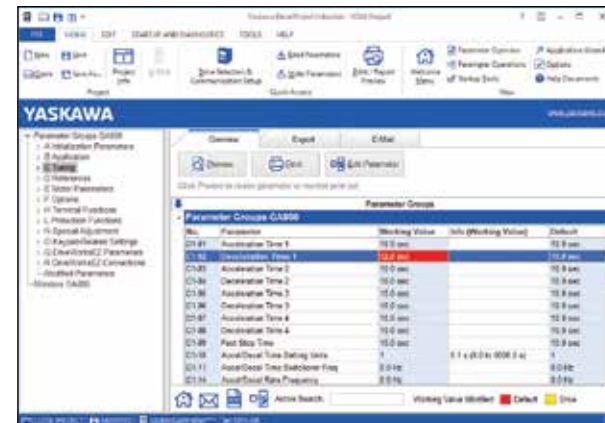

DriveWizard® and DriveWorksEZ® are registered trademarks of Yaskawa.

DRIVEWORKSEZ

DriveWorksEZ provides users with programmable functions to customize U1000, GA800, A1000, and V1000 series AC drives to their specific applications without the need for external control systems such as PLCs. Easily access and command the drive via a symbol-based graphical programming environment.

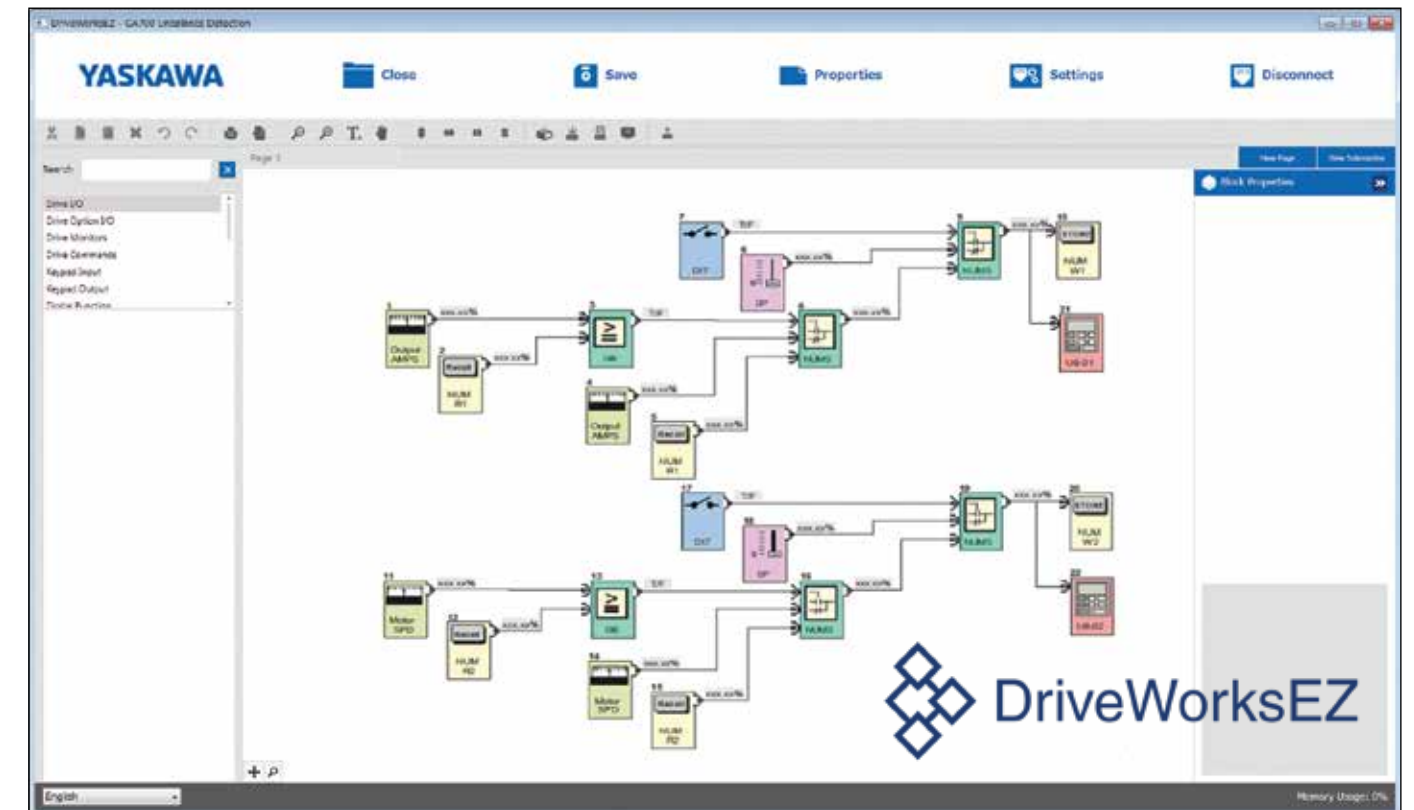

FEATURES

- Simple PLC capability built into the drive
- Eliminates external PLCs/controllers
- Easy-to-use graphical interface
- Fast and constant scan cycles
- Flexible
- Online monitoring
- Process control
- Protected application know-how

EXAMPLES

- Economically optimized water skiing facility**
 - No additional I/Os necessary
 - No PLC required - reduced the system cost to less than 50% of the initial estimate
- Highly precise positioning**
 - Direct access to encoder pulses
 - User-defined units and monitors
- Further examples**
 - Efficient brake sequence
 - Unbalance detection in washing machines

TECHNICAL DATA

CATALOG CODE DESIGNATION

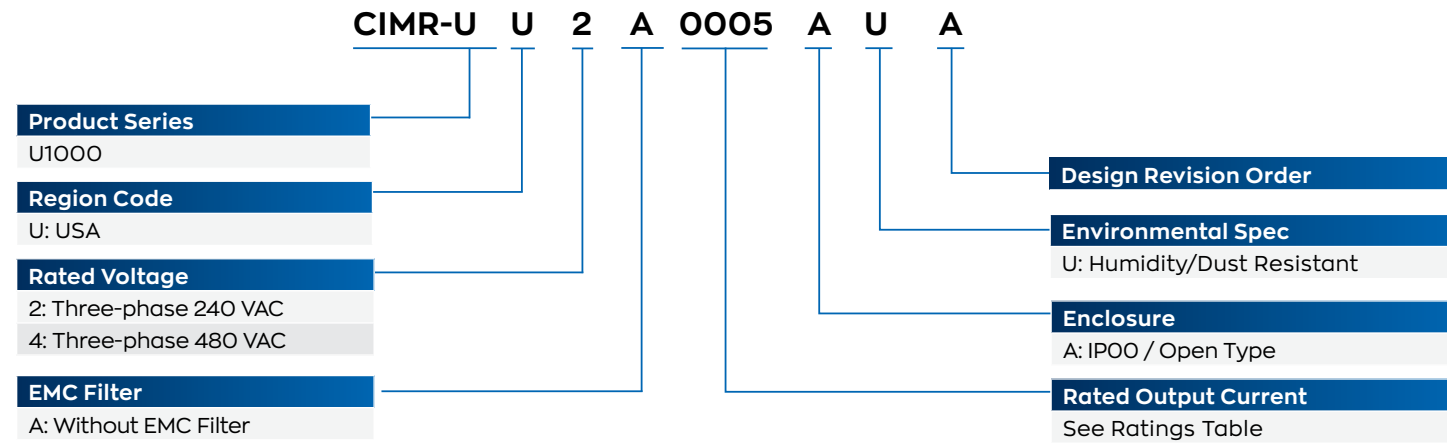

POWER RATINGS

Three-phase, 240 VAC

U1000 Drive CIMR-UU2A□□□□			0028	0042	0054	0068	0081	0104	0130	0154	0192	0248
Applicable Motor Capacity ^{*1}	kW (HP)	HD	5.5 (7.5)	7.5 (10)	11 (15)	15 (20)	18.5 (25)	22 (30)	30 (40)	37 (50)	45 (60)	55 (75)
		ND	7.5 (10)	11 (15)	15 (20)	18.5 (25)	22 (30)	30 (40)	37 (50)	45 (60)	55 (75)	75 (100)
Rated Input Current ^{*2}	A	HD	20	25	38	49	62	74	95	118	140	175
		ND	25	38	49	62	74	95	118	140	175	226
Rated Input Capacity ^{*3}	A	HD	9	12	17	22	28	34	43	54	64	80
		ND	12	17	22	28	34	43	54	64	80	103
Rated Output Current ^{*4,*5}	A	HD	22	28	42	54	68	81	104	130	154	192
		ND	28	42	54	68	81	104	130	154	192	248

Three-phase, 480 VAC

U1000 Drive CIMR-UU4A□□□□			0011	0014	0021	0027	0034	0040	0052	0065	0077	0096	0124
Applicable Motor Capacity ^{*1}	kW (HP)	HD	3.7 (5)	5.5 (7.5)	7.5 (10)	11 (15)	15 (20)	18.5 (25)	22 (30)	30 (40)	37 (50)	45 (60)	55 (75)
		ND	5.5 (7.5)	7.5 (10)	11 (15)	15 (20)	18.5 (25)	22 (30)	30 (40)	37 (50)	45 (60)	55 (75)	75 (100)
Rated Input Current ^{*2}	A	HD	8.7	10	13	19	25	31	36	47	59	70	87
		ND	10	13	19	25	31	36	47	59	70	87	113
Rated Input Capacity ^{*3}	A	HD	8	9	12	17	22	28	33	43	54	64	80
		ND	9	12	17	22	28	33	43	54	64	80	103
Rated Output Current ^{*4,*5}	A	HD	9.6	11	14	21	27	34	40	52	65	77	96
		ND	11	14	21	27	34	40	52	65	77	96	124

Three-phase, 480 VAC (Cont.)

U1000 Drive CIMR-UU4A□□□□			0156	0180	0216	0240	0302	0361	0414	0477	0590	0720	0930
Applicable Motor Capacity ^{*1}	kW (HP)	HD	75 (100)	90 (125)	110 (150)	132 (175)	150 (200)	185 (250)	220 (300)	260 (350)	300 (400)	375 (500)	560 (750)
		ND	90 (125)	110 (150)	132 (175)	150 (200)	185 (250)	220 (300)	260 (350)	300 (400)	375 (500)	450 (600)	597 (800)
Rated Input Current ^{*2}	A	HD	113	142	164	197	218	275	329	377	434	537	819
		ND	142	164	197	218	275	329	377	434	537	655	846
Rated Input Capacity ^{*3}	A	HD	103	130	150	180	200	251	300	344	396	490	748
		ND	130	150	180	200	251	300	344	396	490	598	773
Rated Output Current ^{*4,*5}	A	HD	124	156	180	216	240	302	361	414	477	590	900
		ND	156	180	216	240	302	361	414	477	590	720	930

- *1: The motor capacity (HP) refers to an NEC 4-pole motor. The rated output current of the drive should be equal to or greater than the motor current. Select the appropriate capacity drive if operating the motor continuously above motor nameplate current.
- *2: Assumes operation at the rated output current. Input current rating varies depending on the power supply transformer, input reactor, wiring connections, and power supply impedance.
- *3: Rated input capacity is calculated with a power line voltage of 240 V × 1.1.
- *4: The rated output current of the drive should be equal to or greater than the motor rated current.
- *5: Carrier frequency is set to 4 kHz. Current derating is required to raise the carrier frequency.

SPECIFICATIONS

Item	Specification
Overload tolerance	HD rating: 150 % of rated output current for 60 s ND rating: 120 % of rated output current for 60 s (Derating may be required for applications that start and stop frequently)
Carrier frequency	4 kHz (User adjustable up to 10 kHz. Derating may be required.) ^{*1}
Max. output voltage [V]	Proportional to input voltage ^{*2}
Max. output frequency [Hz]	400 Hz (User-adjustable)
Rated voltage / Rated frequency	Three-phase (CIMR-U0000) 380 to 480 VAC 50/60 Hz
Allowable voltage fluctuation	-15 to +10 %
Allowable frequency fluctuation	±3% (Frequency fluctuation rate: 1 Hz/100 ms or less)
Allowable phase power supply voltage unbalance	2% or less
Harmonic current harmonic distortion	Facilitates IEEE 519 Compliance
Input power factor	0.98 % or more (During rated operation)

- *1: 477 A and larger rated drive default to 3 kHz.
- *2: Commercial power mode results in near zero input harmonics. Existing power conditions and operation mode can affect input harmonics.

DRIVE FUNCTIONS

CONTROL FUNCTIONS

Item	Specification
Control methods	V/f Control (V/f), V/f Control with PG (V/f w/PG), Open Loop Vector Control (OLV), Closed Loop Vector Control (CLV), Open Loop Vector Control for PM (OLV/PM), Advanced Open Loop Vector Control for PM (AOLV/PM), Closed Loop Vector Control for PM (CLV/PM)
Frequency control range	0.01 to 400Hz
Frequency accuracy (Temperature fluctuation)	Digital input: within $\pm 0.01\%$ of the max. output frequency (-10°C to $+40^{\circ}\text{C}$) Analog input: within $\pm 0.1\%$ of the max. output frequency ($25^{\circ}\text{C} \pm 10^{\circ}\text{C}$)
Frequency setting resolution	Digital input: 0.01 Hz Analog input: 1/2048 of the maximum output speed setting (11 bit plus sign)
Output speed resolution	0.001Hz
Frequency setting signal	Main speed frequency reference: DC -10 to +10 V (20 k Ω), DC 0 to +10 V (20 k Ω), 4 to 20 mA (250 Ω), 0 to 20mA (250 Ω) Main speed reference: Pulse train input (max. 32 kHz)
Starting torque	150% at 3 Hz (V/f, V/f w/PG), 200% at 0.3 Hz (OLV) 200% at 0 r/min (CLV, AOLV/PM, CLV/PM) 100% at 3 Hz (OLV/PM)
Speed control range	1:40 (V/f, V/f w/PG), 1:200 (OLV) 1:1500 (CLV, CLV/PM) ^{*1} 1:20 (OLV/PM), 1:100 (AOLV/PM)
Speed control accuracy	OLV: $\pm 0.2\%$ ($25^{\circ}\text{C} \pm 10^{\circ}\text{C}$) ^{*2} CLV: $\pm 0.02\%$ ($25^{\circ}\text{C} \pm 10^{\circ}\text{C}$) ^{*2}
Speed response	OLV: 10Hz ($25^{\circ}\text{C} \pm 10^{\circ}\text{C}$) CLV: 250Hz ($25^{\circ}\text{C} \pm 10^{\circ}\text{C}$)
Torque limit	Parameters setting allow separate limits in four quadrants (available in OLV, CLV, AOLV/PM, CLV/PM)
Accel/Decel time	0.0 to 6000.0s (4 selectable combinations of independent acceleration and deceleration settings)
Braking torque	Same value as overload tolerance
Main control functions	Torque Control, Droop Control, Speed/torque Control Switching, Feed Forward Control, Zero Servo Function, Momentary Power Loss Ride-Thru, Speed Search, Synchronous Transfer with Commercial Power Supply, Overtorque/Undertorque Detection, Torque Limit, 17 Step Speed (max), Accel/decel Switch, S-curve Accel/decel, 3-wire Sequence, Auto-tuning (rotational, stationary tuning), Dwell, Cooling Fan on/off Switch, Slip Compensation, Torque Compensation, Frequency Jump, Upper/lower Limits for Frequency Reference, DC Injection Braking at Start and Stop, PID Control (with sleep function), Energy Saving Control, MEMOBUS/Modbus Comm. (RS-422/RS-485 max, 115.2 kbps), Fault Restart, Application Presets, DriveWorksEZ (customized function), Removable Terminal Block with Parameter Backup Function, Online Tuning, Overexcitation Deceleration, Inertia (ASR) Tuning, High Frequency Injection, etc.

PROTECTION FUNCTIONS

Item	Specification
Power supply regeneration	Available
Motor protection	Electronic thermal overload relay
Momentary overcurrent protection	Drive stops when output current reaches about 200% of the rated current
Overload protection	Drive stops after 60 s at 150% of rated heavy duty output current ^{*3}
Overvoltage protection	200V class: Stops when input voltage exceeds approx. 315 V 400V class: Stops when input voltage exceeds approx. 630 V
Undervoltage protection	200V class: Stops when input voltage falls below approx. 150 V 400V class: Stops when input voltage falls below approx. 300 V
Momentary power loss ride-thru	Immediately stop after 2 ms or longer power loss ^{*4} Continuous operation during power loss up to 2 s (standard) ^{*5}
Ground protection	Electronic circuit protection ^{*6}

OPERATING ENVIRONMENT

Item	Specification
Area of use	Indoors
Ambient temperature	-10°C to $+50^{\circ}\text{C}$ (IP00 enclosure) -10°C to $+40^{\circ}\text{C}$ (IP20/UL Type 1 enclosure)
Humidity	95 RH% or less (non-condensing)
Storage temperature	-20°C to $+60^{\circ}\text{C}$ (short-term temperature during transportation)
Altitude	Max. 1,000m (max. 3,000m with output current and voltage derating)
Standards	UL508C, IEC/EN 61800-3, IEC/EN 61800-5-1, EN ISO 13849-1 Cat.3 PLe, IEC/EN 61508 SIL3
Environmental conditions	Class 3CS (chemical gases), Class 3S2 (solid particles)

*1 Current derating is required. Select control modes in accordance with the drive capacity.

*2 The accuracy of these values depends on motor characteristics, ambient conditions, and drive settings. Specifications may vary with different motors and with changing motor temperature. Contact Yaskawa for consultation.

*3 Overload protection may be triggered when operating with 150% of the rated output current if the output frequency is less than 6 Hz.

*4 May be shorter due to load conditions and motor speed.

*5 A separate Momentary Power Loss Ride-Thru Unit is required for the drives if the application needs to continue running during a momentary power loss up to 2 s.

*6 Ground protection cannot be provided when the impedance of the ground fault path is too low, or when the drive is powered up while a ground fault is present at the output.

DIMENSIONS

OPEN CHASSIS (IP00)

240 V Class			Dimensions (inches)				Weight (lb) ¹
Model: CIMR-UU2A□	Amps ND / HD	HP ND / HD	Fig. No.	H	W	D	
0028AUA	28 / 22	10 / 7.5	1	18.89	9.84	14.17	44
0042AUA	42 / 28	15 / 10					
0054AUA	54 / 42	20 / 15					
0068AUA	68 / 54	25 / 20					
0081AUA	81 / 68	30 / 25					
0104AUA	104 / 81	40 / 30	2	32.12	10.39	17.71	132
0130AUA	130 / 104	50 / 40					
0154AUA	154 / 130	60 / 50					
0192AUA	192 / 154	75 / 60	3	38.97	16.33	15.86	245
0248AUA	248 / 192	100 / 75					

480 V Class			Dimensions (inches)				Weight (lb) ¹
Model: CIMR-UU4Ao	Amps ND / HD	HP ND / HD	Fig. No.	H	W	D	
0011AUA	11 / 9.6	7.5 / 5	1	18.89	9.84	14.17	44
0014AUA	14 / 11	10 / 7.5					
0021AUA	21 / 14	15 / 10					
0027AUA	27 / 21	20 / 15					
0034AUA	34 / 27	25 / 20					
0040AUA	40 / 34	30 / 25					
0052AUA	52 / 40	40 / 30					
0065AUA	65 / 52	50 / 40	2	25.60	10.39	16.53	71
0077AUA	77 / 65	60 / 50					
0096AUA	96 / 77	75 / 60					
0124AUA	124 / 96	100 / 75	3	32.12	10.39	17.71	132
0156AUA	156 / 124	125 / 100					
0180AUA	180 / 156	150 / 125	3	38.97	16.33	15.86	245
0216AUA	216 / 180	175 / 150					
0240AUA	240 / 216	200 / 175					
0302AUA	302 / 240	250 / 200	3	44.56	19.29	17.71	388
0361AUA	361 / 302	300 / 250					
0414AUA	414 / 361	350 / 300	Contact Yaskawa	62.8	42.13	17.52	1235
0477AUB	477 / 434	400 / 350					
0590AUB	590 / 477	500 / 400					
0720AUB ²	720 / 590	600 / 500	Contact Yaskawa	72.24	47.64	17.52	1389
0930AUB ³	930 / 900	800 / 750					

PWM Filter Model No.	Applicable Drive Models	Dimensions (inches)			Weight (lb) ¹
		H	W	D	
EJ711800M ²	CIMR-UU4A0720AUB	53.2	27.6	17.3	761
EJ711820M ³	CIMR-UU4A0930AUB				

1. This data represents the drive weight only, not shipping weight.
2. Input PWM filter EJ711800M is required when using CIMR-UU4A0720AUB.
3. Input PWM filter EJ711820M is required when using CIMR-UU4A0930AUB.

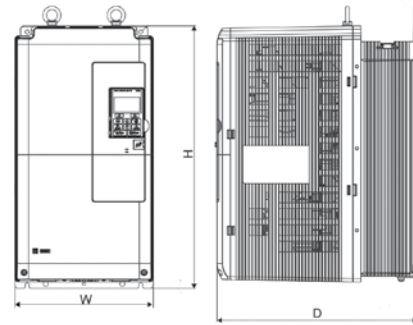

Figure 1

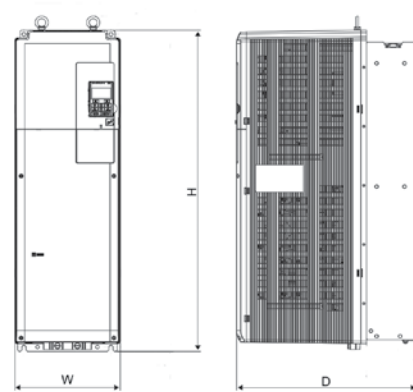

Figure 2

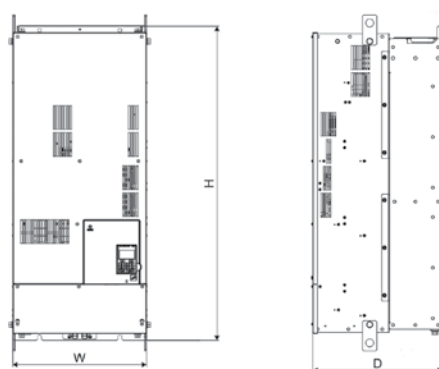

Figure 3



U1000 MATRIX INNOVATION

Improved Energy Efficiency with Direct Conversion from AC to AC

OPTIONS

I/O INTERFACE OPTIONS

Part Number	Description
AI-A3	Analog input card (3 inputs)
AO-A3	2 additional analog output
DI-A3	Digital input (For BCD Code Speed Reference)
DO-A3	Digital output (6 open collector 2 relays)
DI-101	120V Digital Interface (converts existing inputs)

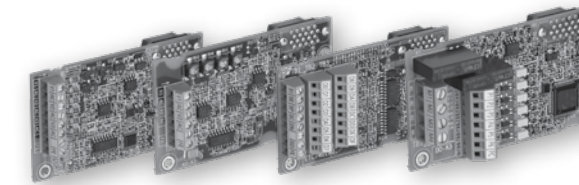

COMMUNICATION OPTIONS

Communication option cards connect a drive to a network. Using this option unit, a master device can:

- Operate the drive
- Monitor the drive operation status
- Read or modify drive parameters

Part Number	Network Communications Option
SI-EN3	EtherNet IP
SI-EN3D	Dual Port EtherNet IP
SI-EM3	Modbus TCP
SI-EM3D	Dual Port Modbus TCP
SI-EP3	ProfiNet
SI-ES3	EtherCAT
SI-N3	DeviceNET with ADR
SI-P3	ProfibusDP
SI-S3	CANopen
SI-T3	MECHATROLINK-II
SI-ET3	MECHATROLINK-III

MOTOR SPEED FEEDBACK

Part Number	Description
PG-B3	Open collector PG-interface 50kHz
PG-X3	Line driver PG-interface 300kHz
PG-F3	EnDat encoder interface card

NEMA 1 KIT

Part Number	Description
EZZO22745A	for 480 V: 11 A, 14 A, 21 A, 27 A, 34 A for 240 V: 28 A
EZZO22745B	for 480 V: 40 A, 52 A, 65 A, 77 A for 240 V: 42 A, 54 A, 68 A, 81 A
EZZO22745C	for 480 V: 96 A, 124 A for 240 V: 104 A, 130 A
EZZO22745D	for 480 V: 156 A, 180 A for 240 V: 154 A, 192 A
EZZO22745E	for 480 V: 216 A, 240 A for 240 V: 248 A
EZZO22745F	for 480 V: 302 A, 361 A, 414 A
EZZO22745G	for 480 V: 477 A, 590 A

24 V POWER CONTROL SUPPLY

The 24 VDC control power option is used to maintain drive control power during a prolonged three-phase power loss (greater than 2 seconds). An external 24 VDC customer power supply is required.

Part Number	Description
PS-U10L	24 V control power option board (240 V Drives)
PS-U10H	24 V control power option board (480 V Drives)

DIGITAL OPERATOR OPTION

- Practical keypad, usable for remote operation. Built-in parameter copy function. For cabinet door mounting use EUOP-V11001
- 5 digit, 8 segment LED operator JVOP-182: Good readability from distance and in dark environment
- Full text LCD keypad JVOP-180: Up to 13 languages

Model Code	Description
EZZO20642A	Operator attachment IP20 with screws
EZZO20642B	Operator attachment IP20 with nuts
JVOP-180	LCD operator 1000 series (standard in U1000 included)
JVOP-182	LED operator 1000 series
UUX000527	Operator Kits, UL Type 3R/UL Type 4X
JVOP-181	Copy unit w\USB converter
UWR0051	1m extension cable for remote digital operator
UWR0052	3m extension cable for remote digital operator



CONNECTION DIAGRAMS

UP TO 590 A RATED CURRENT

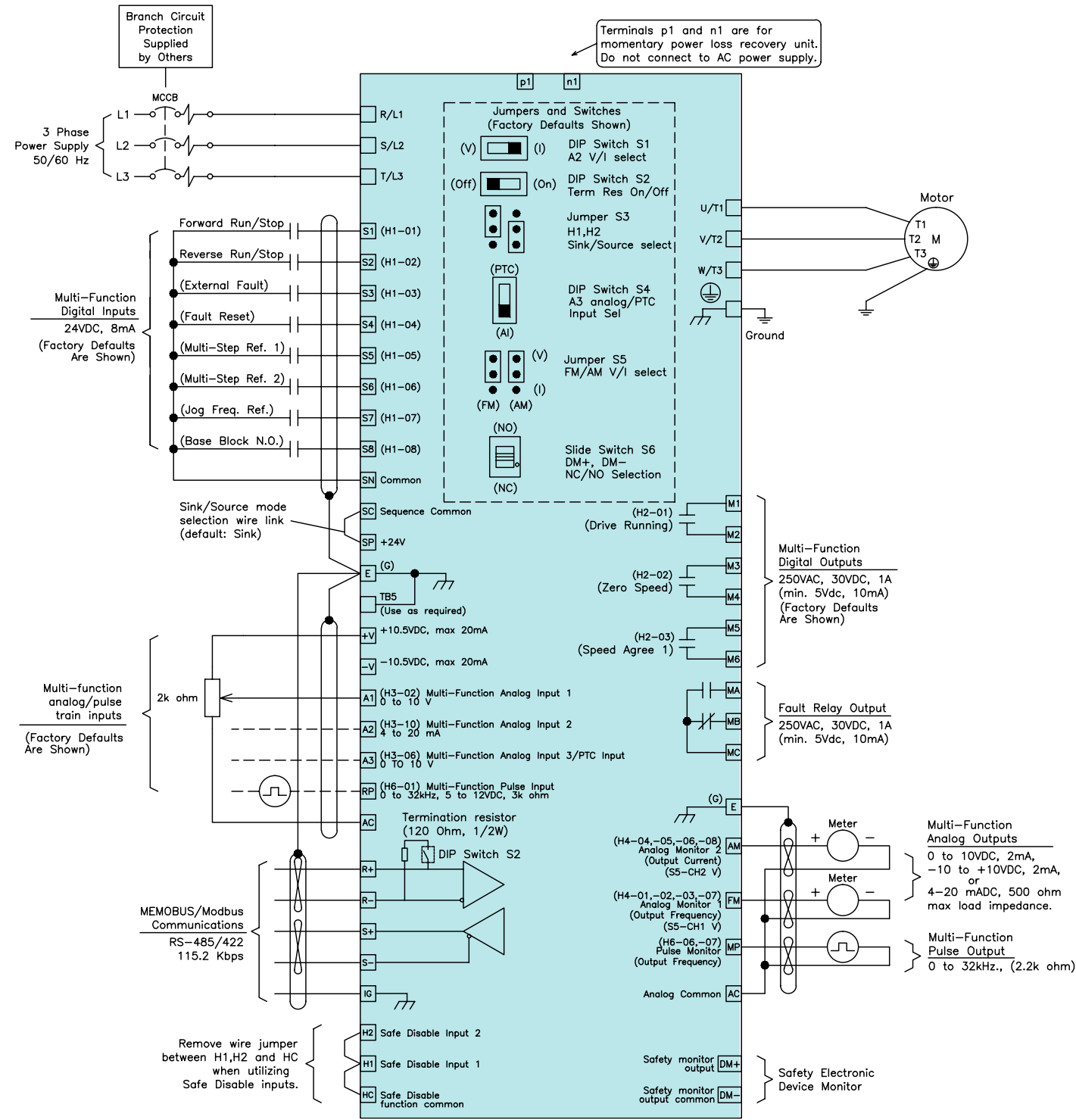

720 A RATED CURRENT AND ABOVE

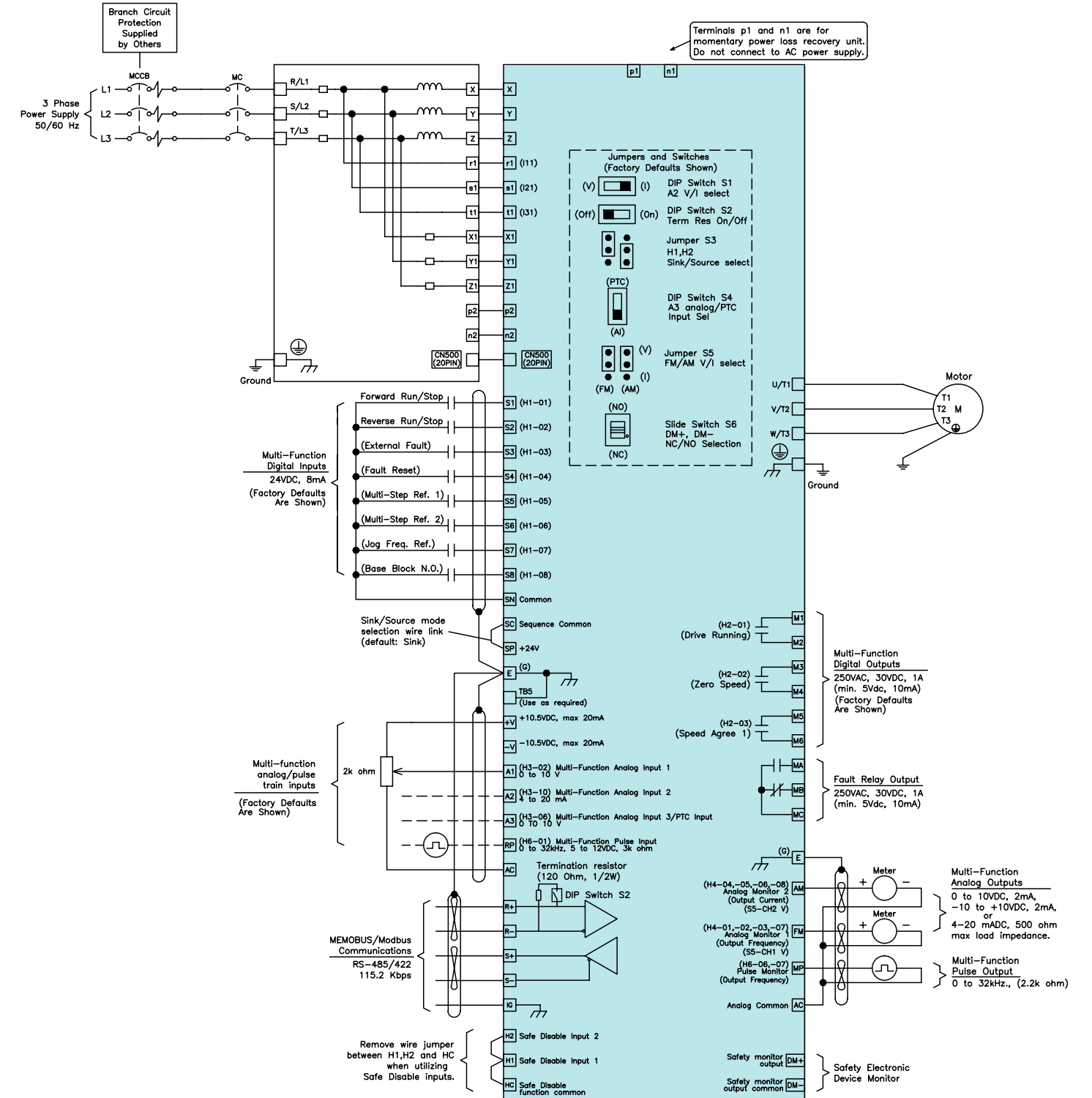

YASKAWA.COM



Yaskawa is the leading global manufacturer of low and medium voltage variable frequency drives, servo systems, machine controllers and industrial robots. Our standard products, as well as tailor-made solutions, are well known and have a high reputation for outstanding quality and reliability.

YASKAWA

Yaskawa America, Inc. | Drives & Motion Division

1-800-YASKAWA | Email: info@yaskawa.com | yaskawa.com

Document No. BLU1000.01 | 03/01/2021 | © 2021 Yaskawa America, Inc.